

F-5: OPEN BULKHEAD LIGHT

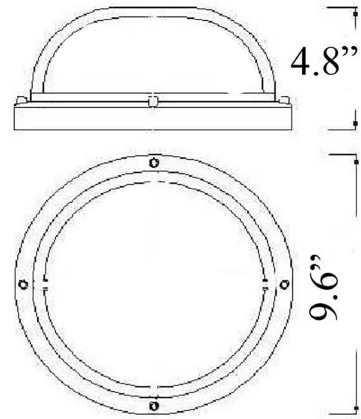

LISTED Suitable for Wet Locations

Interior / Exterior Residential & Commercial Use

Max Wattage:

100w LED Equivalent; 100w Wall, 60w Ceiling Incandescent Bulb ;
Medium Base (E26) Socket, Dimmable (GU-24 also available)

Glass: Frosted Glass

Mounting: 9.6" Mounting Surface, attaches to standard box. All Installation Hardware Provided

Orientation: Can be used as Wall or Ceiling Fixture

Options: Available with On/Off Switch, Hood (B-2) or Cross Bar (B-3)

Material: Solid Brass Construction ; The brass cover is cut from our cages and may show slight signs of air pockets from inside the brass. Please contact us for additional pictures or information.

Available Finishes

Standard Finishes:

Unlacquered Brass – \$455

*Typically in-stock & available
for immediate shipment*

Replacement Glass:

Frosted - \$45

Custom Finishes*: \$575 Each

Brass (Antique, Lacquered, Satin)

Copper (Antique, Polished, Satin)

Nickel (Antique, Polished, Satin)

Oil Rubbed Bronze ~ Pewter

Polished & Satin Chrome ~ Verdigris

Powder Coat (All Colors Available)

Custom Matching Also Available

**Custom Finish Info: 4-8 weeks unless in-stock; Rush Available; Special Orders not Refundable; Custom Lights often in-stock ; Minimum of two lights if not in-stock*

Shiplights
Residential & Commercial Lighting

68 Front St. Marblehead, MA 01945
p. 781-631-3864 f. 781-823-5555
info@shiplights.com
~ A Division of Brass 'N Bounty~

SOLID BRASS ~ WEATHER-PROOF ~ UL LISTED ~ DURABLE